

LEVER TYPE



The tough high pressure cast iron head makes Pro Grease Guns unique in comparison to common pot metal or other die cast heads with a head burst pressure of 17,000 PSI (1200 Bar).

Easy to maintain original pressure and delivery under the hardest working conditions. Delivers .1 ounce per stroke against 7,100 PSI counter pressure.

Heavy duty knurled steel barrel with large threads for easy loading.

Locking follower rod, heavy duty spring, heavy duty beveled rubber follower, no conversion needed for various filling. Use standard 14 oz. cartridge or 16 oz. bulk grease.



Model 1200

Model 1200

Standard Series

Heavy duty cast iron head, with port for optional filler nipple. Curved outlet pipe and coupler with ball check and hardened jaws. Heavy duty barrel with large threads and o'ring seal. Heavy duty rod, spring and follower. Rugged baked enamel finish.



Model 1205

Model 1205

Deluxe Series

Has all the features of model 1200 plus: Filler nipple for 3-way loading. Vinyl handle grip.



Model 1210

Model 1210

Professional Series

Has all the features of Model 1205 plus: Variable stroke cast iron head. Air bleeder valve. Removable valve checks for ease of maintenance. Metallic baked finish. Zinc plated lever handle and linkage.

Model 1212 (Not shown)

Professional Series

Has all features of Model 1210 plus: 360° adjustable outlet pipe, locks in any position.

SUCTION GUN



Model 1225

Model 1225

Professional Series

Clear vinyl flex hose with removable holding clip. Heavy duty, double lipped follower. Heavy duty 16 oz. capacity, knurled barrel. Large positive pull handle. Metallic baked finish.

PISTOL TYPE

Model 1220



Model 1220

Deluxe Series

Heavy duty high pressure cast iron head.
Straight outlet pipe and coupler with ball check and hardened jaws.
Head has port for optional filler nipple.
Heavy duty barrel with large threads and o'ring seal.
Heavy duty rod, spring and follower.
One hand action for hard to reach fittings.
Rugged baked enamel finish.

Model 1221 (Not shown)

Same as 1220 except with flex hose.

Model 1222



Model 1222

Professional Series

Has all the features of Model 1220 Plus:

Removable valve checks for ease of maintenance.
Air bleeder valve.
Filler nipple for 3-way loading.
Metallic baked finish.
Zinc plated handle and linkage.
Positive vinyl handle grip.

Model 1227 (Not shown)

Same as 1222 except with flex hose.

AIR OPERATED

Model 1230



Model 1230

Standard Series

40 to 1 ratio air motor
Filler nipple for 3-way loading
Air bleeder valve
Curved outlet pipe and coupler
Baked enamel and zinc plate finish

Model 1233



Model 1233

Professional Series

60 to 1 ratio air motor
Uses standard grease cartridges
Combination bleeder valve and filler nipple
3-way loading
Heavy duty rod, spring and follower
Curved outlet pipe and coupler with ball check and hardened jaws
Heavy duty barrel with large threads and o'ring seal
Metallic baked finish

Model 1235



Model 1235

Special Industrial Series

60 to 1 ratio air motor
Bulk loading only, will not accept standard grease cartridges
Unique, exclusive air powered follower plate, ideal for heavy greases
Large 33 1/2 oz. capacity heavy duty knurled barrel
Filler nipple for 2-way loading
Wire braid flex hose extension and coupler with hardened jaws
Metallic baked finish

GREASE WHIP HOSE WIRE BRAID HOSE 3000 PSI WORKING, 12,000 PSI BURST

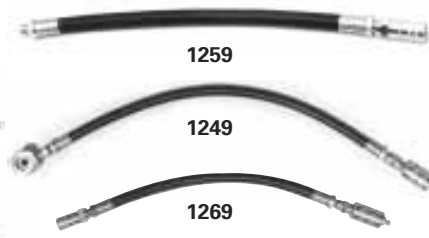

Model	Description
1260	12" length - 1/8" NPTM both ends
1262	18" length - 1/8" NPTM both ends
1264	24" length - 1/8" NPTM both ends
1229	18" whip hose with giant buttonhead coupler
1249	18" whip hose with giant buttonhead coupler and lock sleeve
1259	12" whip hose with 4 jaw narrow coupler
1269	12" whip hose with 4 jaw coupler and lock sleeve

OUTLET PIPES AND COUPLERS

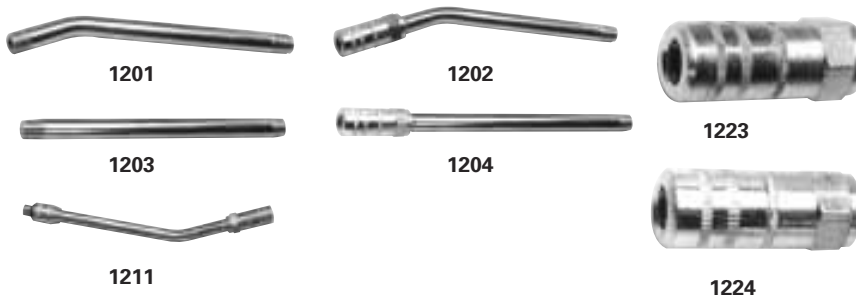

For use with hand operated equipment only

Model	Description
1201	6" curved outlet pipe - 1/8" NPTM both ends
1202	6" curved pipe with 4 jaw narrow coupler
1203	6" straight outlet pipe - 1/8" NPTM both ends
1204	6" straight pipe with 4 jaw narrow coupler
1211	6" curved pipe with 360° adjustable, locking outlet nut and 4 jaw coupler
1223	3 jaw narrow coupler - 1/8" NPTF
1224	4 jaw narrow coupler - 1/8" NPTF

BUTTONHEAD FITTINGS

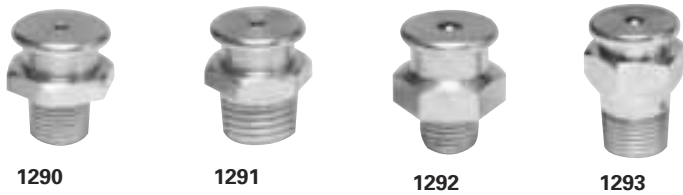

Model	Description
1290	Standard - 1/8" MPT
1291	Standard - 1/4" MPT
1292	Giant - 1/4" MPT
1293	Giant - 3/8" MPT

PLASTIC FUNNELS AND MEASURES



Model	Description
2351	7 1/2" funnel, flex-spout, filter, anti-splash rim, fingergrip
2352	Large heavy duty funnel with regular filter
2353	Large heavy duty funnel with diesel filter
2377	5 quart flex-spout measure, quart and liter calibration and now includes lid

BRASS PUMP & HEAVY DUTY HIGH PRESSURE MACHINE OILERS



Model	Description
2315	1 quart brass pump, steel can, flex spout
2326	1 pint, heavy duty, high pressure, cast iron pump with filter screen, rigid spout
2328	1 1/2 pint heavy duty high pressure, cast iron pump with filter screen, rigid spout

Grease fittings

1/4" - 28 Taper

Model	Description
651	1/4" - 28 Taper thread, short, straight
652	1/4" - 28 Taper thread, med, straight
653	1/4" - 28 Taper thread, long, straight
656	1/4" - 28 Taper thread, 90° angle
657	1/4" - 28 Taper thread, 45° angle

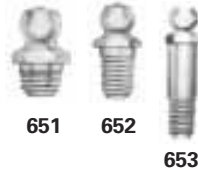

651

652

653



656

657

Drive Type

Model	Description
662	1/4" Drive type, straight
666	3/16" Drive type, straight
668	5/16" Drive type, straight



662

666



668

1/8" Pipe

Model	Description
671	1/8" Pipe thread, 30° angle
672	1/8" Pipe thread, 65° angle, short
673	1/8" Pipe thread, 90° angle
674	1/8" Pipe thread, short, straight
675	1/8" Pipe thread, 65° angle, long
678	1/8" Pipe thread, 45° angle
679	1/8" Pipe thread, long, straight



671

672



673

674



675



678



679

1/4" Pipe

Model	Description
687	1/4" Pipe thread, straight
689	1/4" Pipe thread, 65° angle



687

689

Metric

Model	Description
691	6mm x 1.0, straight
692	8mm x 1.0, straight
694	6mm x 1.0, 45° angle
695	8mm x 1.0, 45° angle
697	6mm x 1.0, 90° angle
698	8mm x 1.0, 90° angle



691

692



694

695



697

698

Accessory adapters and couplers



1214

1226

1228



1254

1255



1267

1250



1251

1252

1237

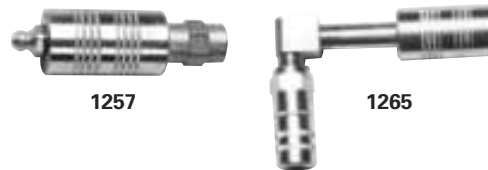

1257

1265



1266

1270

Model	Description
1209	Filler nipple - thin type - 1/8" NPTM
1213	Filler nipple - standard - 1/8" NPTM
1214	Air bleeder valve - 1/8" NPTM
1226	Standard buttonhead coupler- 1/8" NPTF
1228	Giant buttonhead coupler - 1/8" NPTF
1237	Clamp type hand lever grease gun holder
1250	Injector needle adapter
1251	Rubber tip seal-off adapter - 1/8" NPTF
1252	Needle nose adapter - 1/8" NPTF
1254	Needle nose adapter with lock sleeve
1255	Lock sleeve - 1/8" NPTM
1257	Lock sleeve - 1/8" NPTF
1265	90° adapter, coupler and lock sleeve
1266	Threaded swivel adapter
1267	Rubber tip seal-off with lock sleeve
1270	Rigid flex adapter with hydraulic coupler

Couplings



Coupling

2067	1/8" NPT-F x 1/8" NPT-F
2068	1/4" NPT-F x 1/4" NPT-F
2069	3/8" NPT-F x 3/8" NPT-F
2058	3/8" NPT-F x 1/2" NPT-F
2070	1/2" NPT-F x 1/2" NPT-F
2071	3/4" NPT-F x 3/4" NPT-F
2073	1" NPT-F x 1" NPT-F
2537	3/4" NPT-F x 1" NPT-F

Hex Nipples



Nipple

2050	1/8" NPT-M x 1/8" NPT-M
2044	1/8" NPT-M x 1/4" NPT-M
2051	1/4" NPT-M x 1/4" NPT-M
2048	1/4" NPT-M x 3/8" NPT-M
2052	3/8" NPT-M x 3/8" NPT-M
2035	3/8" NPT-M x 1/2" NPT-M
2053	1/2" NPT-M x 1/2" NPT-M
2094	3/4" NPT-M x 1/2" NPT-M
2054	3/4" NPT-M x 3/4" NPT-M
2055	1" NPT-M x 1" NPT-M
2521	1/8" NPT-M x 3/8" NPT-M
2522	1/2" NPT-M x 1/4" NPT-M
2523	3/4" NPT-M x 3/8" NPT-M
1953	1" NPT-M x 3/4" NPT-M

Swivel-Unions - M x F



Swivel

1951	1/2" NPT-M x 3/8" NPT-F
1949	1/2" NPT-M x 1/2" NPT-F
1957	3/4" NPT-M x 1/2" NPT-F
1952	3/4" NPT-M x 3/4" NPT-F
1954	1" NPT-M x 3/4" NPT-F
1955	3/4" NPT-M x 1" NPT-F
1948	3/8" NPT-M x 3/8" NPT-F
1942	1/4" NPT-M x 1/4" NPT-F
1943	3/8" NPT-M x 1/2" NPT-F
1944	1/4" NPT-M x 3/8" NPT-F
1945	1/2" NPT-M x 3/4" NPT-F
1946	1" NPT-M x 1" NPT-F

Swivel-Unions - F x F



Swivel

1958	3/4" NPT-F x 3/4" NPT-F
1960	1/4" NPT-F x 1/4" NPT-F
1961	3/8" NPT-F x 1/4" NPT-F
1962	3/8" NPT-F x 3/8" NPT-F
1963	1/2" NPT-F x 3/8" NPT-F
1964	1/2" NPT-F x 1/2" NPT-F
1965	3/4" NPT-F x 1/2" NPT-F
1966	1" NPT-F x 3/4" NPT-F
1967	1" NPT-F x 1" NPT-F



Swivel

1947	1/4" M x 1/4" F 90° swivel
1950	1/2" NPT-M x 1/2-27" M

Bushings



Bushing

2059	1/4" NPT-M x 1/8" NPT-F
2060	3/8" NPT-M x 1/4" NPT-F
2063	3/8" NPT-M x 1/8" NPT-F
2061	1/2" NPT-M x 3/8" NPT-F
2062	1/2" NPT-M x 1/4" NPT-F
2064	1/2" NPT-M x 1/8" NPT-F
2046	3/4" NPT-M x 3/8" NPT-F
2065	3/4" NPT-M x 1/2" NPT-F
2500	1" NPT-M x 1/2" NPT-F
2066	1" NPT-M x 3/4" NPT-F
2097	1/2" NPT-M x 1/2" NPT-F
2581	1/8" NPT-M x 3/8" NPT-F
2582	1/8" NPT-M x 1/2" NPT-F
2583	1/4" NPT-M x 1/2" NPT-F
2584	3/8" NPT-M x 3/8" NPT-F
2585	1/2" NPT-M x 1/8" NPT-F
2586	1/2" NPT-M x 3/4" NPT-F
2587	3/4" NPT-M x 1/4" NPT-F
2023	1 1/2" NPT-M x 1" NPT-F
2561	1 1/2" NPT-M x 3/4" NPT-F

Reducing Adapters-Pipe



Adapter

2096	1/8" NPT-M x 1/4" NPT-F
2501	1/4" NPT-M x 3/8" NPT-F
2502	1/4" NPT-M x 1/2" NPT-F
2511	1/2" NPT-M x 3/4" NPT-F
2075	1/2" NPT-M x 3/4" GHT-F
2095	3/4" GHT-M x 1/2" NPT-M
2025	3/4" GHT-M x 1/2" NPT-M
2508	3/8" NPT-M x 1/2" NPT-F

90° Swivels - M x F

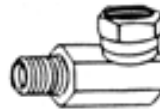

1977	3/8" NPT-M x 1/4" NPT-F
1978	3/8" NPT-M x 3/8" NPT-F
1979	3/8" NPT-M x 1/2" NPT-F
1980	1/2" NPT-M x 3/8" NPT-F
1981	1/2" NPT-M x 1/2" NPT-F
1982	3/4" NPT-M x 3/4" NPT-F
1947	1/4" NPT-M x 1/4" NPT-F

90° Swivels - F x F



1970	1/4" NPT-F x 1/4" NPT-F
1971	3/8" NPT-F x 3/8" NPT-F
1972	3/8" NPT-F x 1/2" NPT-F
1973	1/2" NPT-F x 1/2" NPT-F
1974	3/4" NPT-F x 3/4" NPT-F

Street Elbows



2513	1/2" NPT-F x 1/2" NPT-F
2514	1/2" NPT-M x 1/2" NPT-F
2512	1/2" NPT-M x 1/2" NPT-M
2547	3/8" NPT-M x 3/8" NPT-F
2548	3/4" NPT-M x 3/4" NPT-F
2549	1" NPT-M x 1" NPT-F

Special Steel Nipples

2047	1/2-27" M x 1/8" NPT-M
2056	1/2-27" M x 1/4" NPT-M
2040	1/2-27" M x 1/2-27" M
2049	1/2-27" M x 3/8" NPT-M
2036	1/2-27" M x 1/2" NPT-M



Nipple

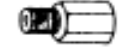

Adapter



Coupling



Bushing

Special Reducing Adapters

2034	1/2-27" M x 1/8" NPT-F
2041	1/2-27" M x 1/4" NPT-F
2033	1/2-27" M x 3/8" NPT-F
2017	1/2-27" F x 1/8" NPT-M
2042	1/2-27" F x 1/4" NPT-M

Couplings

2019	1/8" NPT-F x 1/2-27" F
2038	1/4" NPT-F x 1/2-27" F
2072	3/8" NPT-F x 1/2-27" F

Bung Bushings

Model	Fits
2028	PM3 55:1
360 001	PM2 1:1 and PM4 3:1
360 006	PM6 10:1, 296SS and 496SS
360 007	1000 and 1008
366 000	PM2 3:1 and PM4 8:1
366 002	PM4 5:1
410 001	PM6 55:1
410 002	PM3+3 60:1



Bushings

2043	1/2-27" F x 3/8" NPT-M
2037	1/2-27" F x 1/2" NPT-M

High Pressure Needle Valve

10,000 PSI

2077	1/2" NPTF
2089	3/4" NPTF
2093	1" NPTF

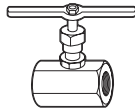

Medium Pressure Ball Valve

2,000 PSI

2074	1/2" NPTF
2083	3/4" NPTF
2090	1" NPTF

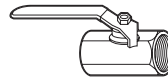

Low Pressure Ball Valve

400 PSI

2013	1/4" NPTF
2088	1/2" NPTF
2091	3/4" NPTF
2084	1" NPTF



TANK GAUGES, VENT CAPS, BUSHINGS

Model 2641



Tank Gauges - Swing Arm

Model 2640	32" - Work Bench Tanks
Model 2641	44" - 275 Gallon Oval Tank
Model 2642	48" - 500 Gallon Horizontal Round
Model 2643	60" - 500 Gallon and Larger Cube Tanks
Model 2644	72" - Tanks with 72" interior height

Fill Caps and Tank Vents

Model 2631	2" Vented style Fill Cap with hinged cover
Model 2632	2" Standard (mushroom) Vent
Model 2633	3" Emergency Vent
Model 2634	4" Emergency Vent

Double Tap Bushing

Model 2613	Standard 2" M x 1 1/2" F bushing
Model 2615	For mounting 3:1 stub pumps directly to double tap bushing
Model 2616	For mounting 5:1 stub pumps directly to double tap bushing
Model 2617	For mounting 10:1 stub pumps directly to double tap bushing

Overfill Shutoff and Alarm

Model OA-1

Non-electric, float level sensor alarm with automatic overfill shut-off valve and alarm whistle. Fits virtually all single wall tanks. Rotating mounting collar allows 360° indexing of the float.

Stub Pump Adapter Kit

Model 2551 (Not Shown)

Adapter kit includes:

Nipples, couplers, adapters, bushings, etc. to install Samson stub pumps as replacement pumps for major competitive stub pumps already installed in the field. Instructions included.



Model 2634



Model 2631



Model 2613



Model OA-1

AIR REGULATORS AND GAUGES



Model 970	1/4"
Model 973	3/8"
Model 976	1/2"
Model 980	3/4"

FILTERS WITH AUTO DRAIN



Model 972	1/4"
Model 975	3/8"
Model 978	1/2"
Model 982	3/4"

LUBRICATORS



Model 971	1/4"
Model 974	3/8"
Model 977	1/2"
Model 981	3/4"

FILTER, REGULATOR, LUBRICATOR WITH AUTO DRAIN



Model 983	1/4"
Model 984	3/8"
Model 985	1/2"
Model 986	3/4"
Model 988	Mounting bracket for 1/2" and 3/4" package.
Model 987	Mounting bracket for 1/4" and 3/8" package.

FILTER, REGULATOR, COMBO UNITS WITH AUTO DRAIN



Filter with auto drain and air regulator in compact unit.

Model 952	3/4"
Model 956	1/4"
Model 957	3/8"
Model 958	1/2"

MINIATURE UNITS WITH AUTO DRAIN



Model 991	1/4" Regulator
Model 993	1/4" Filter
Model 992	1/4" Lubricator
Model 995	1/4" FRL package
Model 955	1/4" Filter regulator combo

GAUGES



Model 979	Standard 1/4" rear mount
Model 994	Mini 1/8" rear mount

COUPLER/CONNECTOR INTERCHANGE

ARO SERIES

This series of couplers and connectors is engineered to interchange with the ARO design as well as similar designs of other manufacturers.

1/4" Body Size Couplers



Thread Size	Female Thread	Male Thread
1/4"	930F04	930M04
3/8"	930F06	930M06

1/4" Body Size Connectors



Thread Size	Female Thread	Male Thread
1/4"	933F04	933M04
3/8"	933F06	933M06

LINCOLN INTERCHANGE SERIES

This series of couplers and connectors is engineered to interchange with the Lincoln interchange design as well as similar designs of other manufacturers.

1/4" Body Size Couplers Lincoln Style



Thread Size	Female Thread	Male Thread
1/4"	950F04	950M04

1/4" Body Size Connectors Lincoln Style



Thread Size	Female Thread	Male Thread
1/4"	953F04	953M04

INDUSTRIAL INTERCHANGE SERIES

This series of couplers and connectors is engineered to interchange with the industrial interchange design of all manufacturers.

3/8" Body Size Couplers



Thread Size	Female Thread	Male Thread
1/4"	935F04	935M04
3/8"	935F06	935M06
1/2"	935F08	935M08

3/8" Body Size Connectors



Thread Size	Female Thread	Male Thread
1/4"	936F04	936M04
3/8"	936F06	936M06
1/2"	936F08	936M08

1/2" Body Size Couplers



Thread Size	Female Thread	Male Thread
3/8"	938F06	938M06
1/2"	938F08	938M08

1/2" Body Size Connectors



Thread Size	Female Thread	Male Thread
3/8"	947F06	947M06
1/2"	947F08	947M08

SPECIFICATIONS

Series Body Style	Body	Sleeve	CFM	Locking Device	Internal Valve	Seals	PSI	Temp Min/Max
ARO	Brass	Brass	34	4 Stainless balls	Zinc Plated Steel	BUNA N	300	-40 F to 250 F
Lincoln	Brass	Brass	32	3 Pawls	Zinc Plated Steel	BUNA N	300	-40 F to 250 F
Industrial; 3/8" body	Zinc Plated Steel	Zinc Plated Steel	65	8 Stainless Balls	Zinc Plated Steel	BUNA N	300	-40 F to 250 F
Industrial; 1/2" body	Zinc Plated Steel	Zinc Plated Steel	150	8 Stainless Balls	Zinc Plated Steel	BUNA N	300	-40 F to 250 F

AIR / FLUID SERVICE

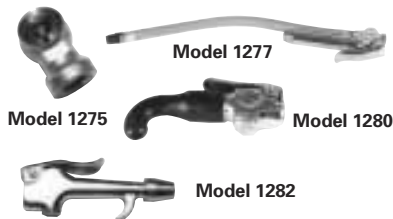

Model 1275	Air chuck 1/4" NPTF
Model 1277	Inflator gauge 1/4" NPTF
Model 1280	Water bibb 1/4" NPTF
Model 1282	Air blow gun 1/4" NPTF

AIR OVER-RUN VALVES



Model 2525	1/4" NPT inlet/outlet
Model 2550	1/2" NPT inlet/outlet

LOW PRESSURE SHUT OFF VALVES



Fully-Ported Ball Valve

Model 2013	1/4" NPTF
Model 2088	1/2" NPTF
Model 2091	3/4" NPTF
Model 2084	1" NPTF



Mini Ball Valve

Model 950 321	1/4" NPTM x NPTF
Model 950 318	3/8" NPTM x NPTF
Model 950 319	1/2" NPTM x NPTF

BARREL PUMPS

Model 605 001



Model 605 001

Heavy Duty lever action barrel pump. Constructed of steel and aluminum with four position lever to adjust for different fluid viscosities or delivery rate. Equipped with a flex spout. Telescopic suction tube included, adjusts from 26" to 42" to accommodate drums from 16 to 55 gallons. Adjustable delivery per stroke, 3.3 oz., 5 oz. , 6.7 oz., or 8.5 oz.

Model 605 002

Same as above but with Rigid Outlet

Model 605 003

Same as above but with Dispense Hose

Model 1240



Model 1240

Lever action barrel pump. Steel pump body, spout and telescopic suction tube. Die cast head, steel piston, brass rings and nitrile rubber seals. Bung threads fits 16-55 gallon drums. Ideal for use with light viscosity lubricants and other non-corrosive fluids.

Model 1243



Model 1243

Same features as Model 1240 plus: A larger pump body with greater internal volume. Has Viton® seals, useable with alcohols, detergents, solvents, oils and anti-freeze. Long curved removable steel spout.

Model 1244



Model 1244

Lever action siphon pump. Design allows transfer by siphon once the pump has been primed, giving a continuous flow of two gal/min. Bung threads fits 16-55 gallon drums. With 3' clear delivery hose, metal nozzle and PVC suction tube. For anti-freeze, light mineral oil, diesel, detergent and other automotive and petroleum light fluids.

Model 1245



Model 1245

Rotary barrel pump. Heavy duty cast iron body, telescopic steel suction tube, adjustable bung fits 16-55 gallon drums. Dispenses fuel oils, kerosene, diesel fuel, oils and other light fluids.

Model 1247



Model 1247

Constructed of nylon, stainless steel and special packings. Fits 16-55 gallon drums with a 2-inch bung opening. Spout can be removed and special hose attached. Dispenses strong chemicals and solvents at approximately 8 oz. per stroke.

CHEMICAL HAND PUMPS



Rotary

Model 8013

Lightweight rotary pump manufactured in PVC to handle chemicals and acid based products. Features bi-directional operation. Delivery is rated at over 4.75 gpm at 60 cycles per minute. Includes adjustable bung bushing and a 3 piece down tube that extends from 13 to 37 inches (945mm) to fit most containers, including 5, 16 and 55 gallon commercial sizes.



Lever Action

All Polypropylene construction, 2" NPT bung threads and a unique adjustable locking nut to allow the pump to be fixed in the proper position on the barrel for dispensing. Delivers over ½ quart per stroke (500cc). The telescopic suction tube extends from 12.5 to 37 inches (945mm) to fit most containers, including 5, 16 and 55 gallon commercial sizes.

Model 3006- with EPDM seals

Model 3007- with Viton seals

Model 8010

Polypropylene 6 foot (2 meter) dispensing hose to fit 3006/3007.



Lift Pump

Model 5807

Grade 316 stainless steel lift pump with Teflon seals, includes 2" bung adapter. Full 33 inch stroke delivers .86 quart. 37 inch (940mm) down tube for 5, 16 and 55 gallon containers. Bung height adjustable from 14 to 35 ½".

See next two pages for chemical compatibility chart

HIGH FLOW PUSH-PULL PUMPS



High Flow Push-Pull Pumps

High volume double acting 'push-pull' hand operated semi-rotary pump with cast iron body and brass vanes suitable for a wide variety of liquids including water, diesel, water based solutions, all petroleum products, and non-corrosive solvents.

Model 5010

Inlet and outlet 1/2" F. Pump output is 4.2 gpm at 60 cycles per minute.

Model 5012

Inlet and outlet 1 1/2" F. Pump output is 10.5 gpm at 60 cycles per minute.

Model 5019

Inlet and outlet 2" F. Pump output is 34.5 gpm at 60 cycles per minute.

Hand Operated Pumps

The following recommendations are based on information derived from a combination of practical experience, raw material suppliers, chemical manufacturers, and careful examination of available published information. However, since the resistance of MATERIALS can be affected by concentration, temperature, presence of other chemicals, thickness of section, and other factors, this information should be considered as a general guide rather than a definitive document. Ultimately the customer must determine the suitability of the pump for the application for which it is intended. Samson Corporation can not accept liability for any accident or damage occurring while using any of our range of pumps. All recommendations assume ambient temperature. Should any particular chemical not appear on the chart, then we would ask you to check with our technical department that will be pleased to assist with a suitable recommendation for your specific requirement.

● = Suitable

	3007	3006	8013	5807
Acetaldehyde		●		●
Acetamide				●
Acetate Solvent		●	●	●
Acetic Acid		●	●	●
Acetic Acid Glacial		●		●
Acetic Anhydride				●
Acetone				●
Acetylene Tetrabromide		●		●
Acid Benzoic Solution	●			●
Acid Copper Solution		●		
Acrolein		●		
Alcohols				
Amyl			●	●
Benzyl				●
Butyl	●		●	●
Diacetone				●
Ethyl			●	●
Hexyl			●	●
Isobutyl				●
Isopropyl	●			●
Methyl	●		●	●
Octyl		●		●
Propyl				●
Acrylonitrile				
Aldehyde Acetaldehyde	●	●		
Alkyl Arysulphonic Acid		●		
Alkylate Light	●	●		
Allyl Ketone		●		
Alum Solution				●
Aluminium Chloride	●		●	
Aluminium Flouride			●	
Aluminium Hydroxide			●	●
Aluminium Sulphate	●		●	
Amines				●
Ammonia			●	●
Anhydrous Ammonia		●	●	●
Ammonium Acetate			●	●
Ammonium Nitrate	●		●	●
Ammonium Bifluoride			●	●

	3007	3006	8013	5807
Ammonium Carbonate		●	●	●
Ammonium Chloride			●	●
Ammonium Bicarbonate			●	●
Ammonium Hydroxide		●	●	●
Ammonium Nitrate			●	●
Ammonium Persulphate			●	●
Ammonium Phosphate			●	●
Ammonium Sulphate	●		●	●
Aqueous Ammonia		●	●	●
Amyl Acetate				●
Amyl Alcohol			●	●
Amyl Chloride	●			
Anhydride				
Aniline liquid		●		●
Aniline Hydrochloride		●		
Anti-Freeze			●	●
Antimony Trichloride			●	
Aromatic Hydrocarbons	●			●
Arsenic Acid	●		●	●
Auto Transmission Fluid	●			●
Barium Carbonate			●	●
Barium Chloride	●		●	●
Barium Cyanide			●	●
Barium Hydroxide	●		●	●
Barium Nitrate	●		●	●
Barium Sulphate			●	●
Barium Sulphide	●		●	●
Benzaldehyde				●
Benzene				●
Benzoic Acid	●		●	●
Benzol				●
Benzyl Chloride	●			
Bleach Solutions		●		●
Borax (Sodium Borate)		●	●	●
Boric Acid	●		●	●
Bromine			●	
Butadiene	●		●	●
Butanol			●	●
Butylene		●	●	●
Butyric Acid			●	●
Calcium Bisulphate	●		●	●
Calcium Bisulphide	●		●	
Calcium Bisulphite	●		●	●
Calcium Carbonate	●		●	●
Calcium Chlorate			●	●
Calcium Chloride	●		●	●
Calcium Hydroxide	●		●	●
Calcium Hypochlorite				
Calcium Sulphate			●	●
Carbolic Acid (Phenol)	●		●	●
Carbon Bisulphide				●
Carbon Disulphide				●
Carbon Tetrachloride				
Carbonic Acid			●	
Caustic Soda (Sod. Hydrox)		●	●	
Cellulose		●		
Cellulose Thinners				●
Chloratic Acid				
Chloroacetic Acid		●		
Chloroacetylhydride		●		
Chloric Acid				
Chlorine Liquid				
Chlorine Water			●	

	3007	3006	8013	5807
Chlorobenzene				●
Chlorox (Bleach)			●	●
Chromic Acid	●		●	
Citric Acid	●		●	●
Copper Ammonium Acetate		●	●	
Copper Chloride	●		●	
Copper Cyanide	●		●	●
Copper Fluoride			●	
Copper Nitrate			●	●
Copper Plating Solution		●	●	
Copper Sulphate	●		●	●
Creosote	●	●		●
Cresylic Acid		●	●	●
Crotonaldehyde			●	
Cupric Chloride				
Cyanogen		●	●	
Cyclohexane				●
Cyanic Acid		●	●	
Cyclohexylamine		●	●	
Cycloic Acid				
Detergents	●		●	●
Developing Fluid	●		●	●
Diacetone Alcohol		●	●	●
Diamylamine		●		
Dibutyl Pthalate		●		●
Dichlorethane				
Diesel Fuel			●	●
Diethanolamine		●		
Diethyl Aniline		●		
Diethyl Benzene	●			
Diethyl Carbonate	●			
Diethyl Formaldehyde		●		
Diethyl Hydrazine		●		
Diethyl Maleate		●		
Diethyl Sulphate		●		
Diethyl Triamine		●		
Diethylene Glycol	●			●
Disobutylene				●
Disobutylene Ketone		●		
Dimethyl Aniline		●		
Dimethyl Terephthalate		●		
Diocyl Aniline		●		
Diocyl Amine		●		
Dioxane		●		
Dipentene	●			●
Diphenyl Chlorinate	●			
Divinyl Benzene	●			●
Ethyl Acetate				●
Ethyl Alcohol	●			●
Ethyl Bromide	●			●
Ethyl Chloride				●
Ethyl Mercaptan				●
Ethyl Pyridine				●
Ethyl Sulphate		●		●
Ethylene Bromide	●	●		●
Ethylene Chloride	●			●
Ethylene Diamine		●		●
Ethylene Dibromide	●			●
Ethylene Dichloride		●		●
Ethylene Glycol			●	●
Ethylene Oxide				●
Fatty Acids	●			●
Ferric Chloride	●		●	

CHEMICAL RESISTANCE CHART

	3007	3006	8013	5807		3007	3006	8013	5807		3007	3006	8013	5807
Ferric Nitrate	●		●	●	Methylated Spirits				●	Pthalic Anhydride		●		●
Ferric Sulphate			●		Methyl Acetate		●		●	Pyridine		●	●	
Ferrous Chloride			●		Methyl Acetone		●		●	Pyrogallol Acid			●	●
Ferrous Sulphate			●		Methyl Acetate		●		●	Rosins				●
Fluoric Acid	●		●		Methyl Alcohol		●	●	●	Sal Ammoniac				
Fluorine					Methyl Bromide	●	●			Silver Cyanide Solution	●		●	
Fluorosilicic Acid	●		●	●	Methyl Cellosolve		●			Silver Nitrate	●		●	
Formaldehyde			●		Methyl Chloride		●			Soap Solutions	●	●	●	●
Formic Acid		●			Methyl Dichloride		●			Sodium Acetate		●	●	●
Gallic Acid	●		●	●	Methyl Ethyl Ketone (MEK)		●		●	Sodium Aluminate			●	
Gasoline (SEE NOTE)				●	Methyl Formate		●		●	Sodium Bicarbonate	●		●	●
Glaubers Salts	●				Methyl Isobutyl Ketone				●	Sodium Bisulphate			●	
Glycerine			●	●	Methyl Isopropyl Ketone				●	Sodium Bisulphite			●	
Heptane	●		●	●	Methylene Chloride	●			●	Sodium Borate				
Hexachloro Acetone		●			Methylene Dichloride	●				Sodium Carbonate				
Hexamine		●		●	Monochloroacetic Acid		●			Sodium Chlorate			●	
Hexane		●		●	Monochloro Benzene	●			●	Sodium Chloride			●	
Hydraulic Oil - Petroleum	●		●	●	Monwitro Chloro Benzene	●			●	Sodium Chromate			●	●
Hydraulic Oil - Synthetic	●		●	●	Monoethanolamine		●			Sodium Cyanide			●	
Hydrobromic Acid		●	●		Muriatic Acid	●				Sodium Fluoride				
Hydrochloric Acid	●		●		Naptha			●	●	Sodium Hydrosulphite	●			
Hydrocyanic Acid		●	●		Napthalene			●		Sodium Hydroxide				
Hydrofluoric Acid					Naphthenic Acid					Sodium Hypochlorite (20%)		●	●	
Hydrofluorosilicic Acid		●			Nickel Chloride			●		Sodium Hypochlorite		●	●	●
Hydrogen Bromide					Nickel Sulphate	●		●		Sodium Nitrate			●	●
Hydrogen Fluoride	●				Nitrating Salts			●		Sodium Perborate			●	
Hydrogen Peroxide	●		●		Nitric Acid (up to 20% conc.)	●	●	●	●	Sodium Peroxide			●	●
Hydrogen Sulphide			●	●	Nitric Acid (up to 50% conc.)			●	●	Sodium Sulphide			●	
Hydroxy Acetic Acid		●	●		Nitric Acid (concentrated)			●	●	Sodium Sulphite			●	
Ink				●	Nitrobenzene	●				Sodium Thiosulphate			●	●
Iodine		●			Oleic Acid	●		●	●	Solvents (General **)				●
Iodoform		●		●	Oleum				●	Stannic Chloride	●		●	
Iron Pyritic Acid		●			Oxalic Acid		●	●		Stannous Chloride	●		●	
Iron Sulphate Solution	●				Paint Thinners				●	Stearic Acid			●	●
Iso-Butylene		●			Palmitic Acid	●				Stoddard Solvent			●	●
Iso-Butyl Methyl Ketone		●			Paraffin	●		●	●	Sulphur Chloride			●	
Iso-Butyraldehyde		●			Pentachloroethylene				●	Sulphur Dioxide		●		●
Iso Cyanate		●			Pentane	●				Sulphuric Acid (up to 10%)	●	●	●	
Iso Propyl Acetate		●			Perchloroethylene	●			●	Sulphuric Acid (10% to 75%)	●	●	●	
Iso Propyl Alcohol		●		●	Phenol (Carbolic Acid)	●		●	●	Sulphuric Acid (above 75%)			●	
Jet Fuel (but SEE NOTE)			●	●	Phosphoric Acid		●	●		Sulphurous Acid			●	
Kerosene	●		●	●	Photographic Developer	●		●	●	Tannic Acid	●		●	●
Ketones		●		●	Picric Acid			●	●	Tartaric Acid			●	●
Laquer Thinners				●	Potassium Bicarbonate	●		●	●	Tetrachlorethane	●		●	
Lactic Acid	●				Potassium Bromide			●	●	Tetrahydrofuran			●	
Lead Acetate Solution	●		●	●	Potassium Bromine			●	●	Toluene, Toluol	●		●	
Lead Nitrate Solution			●		Potassium Carbonate			●	●	Tributyl Phosphate			●	
Linseed Oil	●		●	●	Potassium Chlorate			●	●	Trichloro Benzene	●		●	
Lithium Chloride					Potassium Chloride			●	●	Trichlorethane			●	
Lubricants	●		●	●	Potassium Chromate			●		Trichlorethylene			●	
Magnesium Acetate		●	●	●	Potassium Cyanide	●		●		Tricresyl Phosphate			●	
Magnesium Carbonate			●	●	Potassium Dichromate			●	●	Triethanolamine		●		
Magnesium Chloride	●		●		Potassium Ferrocyanide			●		Triethylamine		●	●	
Magnesium Hydroxide			●	●	Potassium Hydroxide			●		Turpentine (White Spirit)			●	●
Magnesium Nitrate			●	●	Potassium Nitrate			●		Vinegar			●	●
Magnesium Oxide			●	●	Potassium Permanganate			●		Weed Killer **			●	●
Magnesium Sulphate			●	●	Potassium Sulphate	●		●		White Spirit (Turpentine)			●	●
Maleic Acid		●	●	●	Potassium Sulphide			●		Xylene			●	
Malic Acid			●	●	Propanol				●	Zinc Chloride	●			
Mercaptans		●			Propionic Acid	●				Zinc Hydrosulphite			●	
Mercuric Chloride		●	●		Propylene Dichloride	●				Zinc Sulphate			●	
Mercuric Cyanide			●	●	Propylene Glycol			●		Zinc Oxide			●	
Methanol (Methyl Alcohol)				●	Picoline Alpha		●			DEF	●	●	●	●

Please Note: Items marked ** are GENERAL HEADINGS for guidance only and cannot be considered comprehensive. Differing formulations can sometimes have more effect than would otherwise be expected.



Model 4014

Heavy duty 14.4 Volt motor. Develops up to 8,000 psi. Complete with heavy duty carrying case, 2 battery packs, charger, 30" flex hose with spring guard and 4-jaw coupler, and instructions.

Model 4024

Replacement 14.4 V Ni-Cad battery

Model 4025

14.4 V Battery charger

Model 4020

Shoulder strap



4024



4025

4038

Model 4038

Heavy duty 18 volt motor. Maximum 10,000 psi. Complete with heavy duty carrying case, 2 battery packs, charger, 30" flex hose with spring guard and 4-jaw coupler, and instructions.

Model 4036

Replacement 18 V Ni-Cad battery

Model 4034

18 V Battery charger for 4038

Model 4037

Shoulder strap

